

TASKI[®]

The **ULTIMATE**
Cleaning Machines™

swingo
250µmicro



Now everyone can achieve professional
floor cleaning results

The swingo 250µmicro delivers the cleaning performance of a machine with the ultimate in convenience, ease and simplicity of a mop.

Now everyone can achieve a professional floor cleaning result.



Reduction in cleaning costs

One pass cleaning means no repeat cleans and no need to wait for floors to dry. With labour over 80% of total cleaning costs, the swingo 250µmicro saving can reduce total cleaning costs by up to 70%.



More effective cleaning results

TASKI scrubber driers remove up to 5 x times more soilage than mopping. A combination of increased cleaning pressure and superior water recovery means floors are visibly cleaner.



Water and chemical reduction

The swingo 250µmicro's super efficient water distribution means that 6,500L of water and associated chemicals are saved every year. That's a 80% reduction compared to mopping. The swingo 250µmicro isn't just a more efficient answer, it's also a more sustainable solution.



Safer and more ergonomic

The foot operated brush and squeegee levers means no bending over and the parking mode means the machine can be safely positioned if unattended. With its safe parking position, low handle weight and convenient transport mode the swingo 250µmicro is so simple to use. Clean faster and smarter, not harder.



We speak the same language. Whatever your sector the swingo 250µmicro is the floor cleaning solution for you.



Hospitality

First impressions count, you know how much your guests value a clean and hygienic establishment. Mechanising your floor cleaning is a simple but effective way to upgrade, it will transform the appearance of your floors. With the swingo 250µmicro your guests will really notice the difference from the moment they enter your building.



Food Service

You work hard to create a memorable experience for your diners. You know how customers value a clean and hygienic establishment. Dirty sticky floors or worse smelly wet floors are a quick way to lose customers. First impressions really do count, the swingo 250µmicro will transform the appearance of your floors and your diners will really notice. Not only will they keep returning, research shows they will spend more with you.

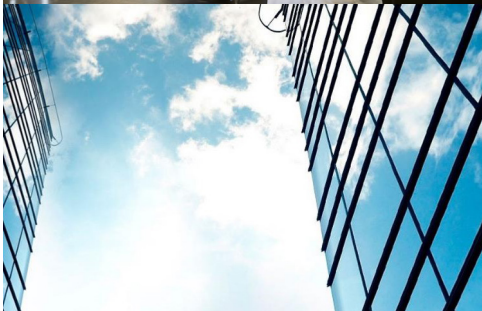

Facilities Management

We understand cleaning is your business and that to reduce your labour bill means more profit or just doing more for your clients. Mechanising more of your cleaning means time saved. The swingo 250µmicro is a game changer, empowering your operatives with the latest technology means tiresome mopping is a thing of the past. They will thank you and so will your clients which has to be a good thing. You know cleaning, take a look at the TASKI swingo 250µmicro.



Transport

You and your teams create a safe and comfortable travel experience for your customers. We know you have a duty of care to protect your team and customers to improve hygiene, air quality and floor safety. As a responsible business you will have sustainability goals, your customers and the public may also have expectations. Sustainability doesn't only mean Green, at TASKI it's Orange. Upgrading from mopping to the swingo 250µmicro can reduce water & chemical consumption by up to 80%. Your stakeholders and the public will be impressed.



Government & Education









Your buildings are the most valuable asset to your establishment. TASKI has the solutions to protect your assets while improving their appearance. At TASKI we pay great attention to ensure our machines are ergonomically designed for the user. The swingo 250µmicro's agility and safe parking mode is perfect for congested areas like classrooms, washrooms and kitchens. The swingo 250µmicro's low handle weight, amazing agility and safe parking mode means user comfort and safety is assured.

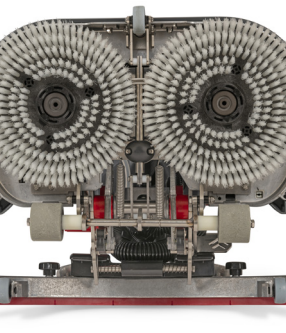

Retail

You know how a clean and hygienic establishment is valued by your customers. Mechanise more your floor cleaning, it will transform the appearance of your floors. Your customers will really notice the difference which will keep them coming back and stay loyal to your brand. The swingo 250µmicro is perfect for retail convenience stores but also ideal for food preparation and customer washrooms in supermarkets.

The swingo 250micro carefully designed to excel at cleaning. Simple.

Simple and intuitive	Ergonomic and comfortable	Lightweight and hygienic	Power and performance	Effectiveness and control
				
<p>Simple dashboard with intuitive controls. Battery life indicators. On/off, vacuum on/off, water on/off.</p>	<p>Full height adjustable for comfort, control and ergonomics.</p>	<p>Easy to remove, fill and clean water tanks. Easy to clean and keep hygienic.</p>	<p>Powerful and long-lasting lithium Li-ion battery with fast charging and extra long life.</p>	<p>Low RPM with good brush pressure makes for effective soilage removal.</p>
Efficiency and sustainability	Agility and safety	Ease of use	Stability and convenience	Flexibility and simplicity
				
<p>Fully adjustable water distribution. Cover more space with less water.</p>	<p>In the unlikely event of contact, non-marking soft touch bumper guide protect fixtures and fittings.</p>	<p>Foot operated floor brush & squeegee mechanisms. No bending required.</p>	<p>Unique parking mode ensures safe upright parking whilst in use. No bending or unsafe practices when furniture or obstacles are encountered.</p>	<p>Brush for simplicity or pad option for full flexibility. The Twister green pad is available for outstanding results.</p>

More soilage and water removed in less time for cleaner safer floors.

Battery status

Vacuum (on/off)

Water (on/off)

Yellow start button



Orange parking button

Height adjustment lever

Left and right control levers



Orange parking button for safe parking



Efficient squeegee with 2 guide wheels and 3 floor wheels



Foot operated brush and squeegee mechanism



3L recovery tank with clear cover and ball float cut off

Easy to fill 2.2L clean water tank



Non-marking soft touch bumper guide



Low 140 RPM and high brush pressure

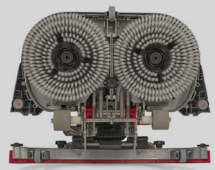

Fully adjustable water flow. Up to 682m²/tank



2 x 80mins batteries. 1hr recharge time



TASKI[®]The **ULTIMATE**
Cleaning Machines™**swingo 250µmicro****Article code**

SH7524889

Model

TASKI 250µmicro Starter kit

Technical specification**Metric****Imperial**

Productivity (m ² /hr / ft ² /hr)	1,320	14,208
Working width (cm / inches)	44	17.3
Solution tank (L / US gal)	2.2	0.58
Recovery tank (L / US gal)	3	0.79
Battery autonomy (mins)	60-80	60-80
Recharge time (hrs @ 80%)	1	1
Weight RTU with battery & water (kg / lb)	25	55.1
Brush pressure (g/cm ² / lb/inch)	20.10	0.28
Brush speed (RPM)	140	140
Typical coverage per tank	682	7,341
Coverage per charge (m ² / ft ²)	2,150	23,142

(Machine supplied complete with 2 x batteries, charger, and 2 brushes)

For more information go to www.TASKI.com

TASKI

The **ULTIMATE**
Cleaning Machines



TASKI is one of four core areas of the Diversey business.

TASKI The ULTIMATE Cleaning Machines
For more information, visit www.taski.com or follow us on social media.



Whatever sector you work in,
the swingo 250µmicro is the floor
cleaning solution for you.

www.taski.com

TASKI is one of four core areas of the Diversey business. All logos and trademarks are owned by or licensed to Diversey, Inc. © 2021 Diversey, Inc. All Rights Reserved. 88590-LIT master (21/147)